

TARIFA SMATV
CANARIAS
MARZO 2023



1. TV SATÉLITE	06
· Antenas parabólicas	
· Soportes	
· LNBS	
· Multi-LNBs	
· Conmutadores DISEqC	
2. ANTENAS TV Y SOPORTES	10
· Antenas terrestres	
· Soportes y mástiles	
· Torretas	
3. AMPLIFICACIÓN	12
· Amplificadores de interior	
· Amplificadores de mástil	
· Centrales multibanda	
· Amplificadores FI	
· Amplificadores RF + FI	
· Centrales de amplificación	
· Fuentes de alimentación	
4. ICT, PASIVOS, TOMAS TV	14
· Repartidores	
· Derivadores	
· PAUs	
· Tomas TV	
· Rosetas	
· Multiplexores	
· Latiguillos	
5. CABLES, CONECTORES Y HERRAMIENTAS	18
· Cables coaxiales	
· Cables de datos CAT. 5	
· Cables de datos CAT. 6	
· Conectores	
· Adaptadores	
· Cables y accesorios	
· Conectores de cables de datos	
· Fijación y accesorios de instalación	
· Herramientas	

6. MODULADORES Y TRANSMODULADORES	22
· Filtros LTE, mezcladores y complementos	
· Moduladores digitales COFDM HD	
· Transmodulación Terra DVB-S/S2 y DVB-T/T2/ C	
· Unicable	
· Multiswitch Terra	
	24
7. MEDIDORES SMATV	24
· Medidores de Campo profesional	
· Apuntador satélite	
	24
8. FIBRA ÓPTICA TECATEL	24
· Conectores ópticos	
· Adaptadores ópticos	
· Pigtaills	
· Latiguillos	
· Splitters ópticos	
· Torpedos	
· Distribución	
· Conversores	
· Cables	
· Equipos de medida	
· Fusionadora	
· Herramientas y accesorios	
	28
9. TERRA CATV	28
· Sistemas recepción modular - DVB a IP	

CONDICIONES GENERALES DE VENTA

CONDICIONES GENERALES

1. Esta tarifa de precios entra en vigor a partir del 23 de enero del 2023, quedando anulada cualquier otra anterior.
2. Los precios reflejados en esta tarifa son precios de venta al público recomendados (P.V.P.R.) para Península y Baleares. Para Canarias están reflejados en tarifa aparte. Para Ceuta y Melilla consultar. Ninguno de estos precios incluyen el Impuesto sobre el Valor Añadido (IVA), R.A.E.E., ni cualquier tasa aplicable a cada tipo de producto.
3. Periódicamente los precios y condiciones impresos en la presente tarifa pueden ser cambiados en cualquier momento y sin previa comunicación individualizada, estando en la web: www.tecatel.com la tarifa vigente a disposición de todos los clientes, con la información actualizada sobre precios de productos y condiciones.
4. Tecatel, S.L., se reserva el derecho a modificar los precios y características de los productos sin previo aviso*. Los productos serán facturados al precio en vigor de la fecha de recepción del pedido.
5. La realización de un pedido a Tecatel, S.L. significa la aceptación de estas condiciones.
6. Tecatel, S.L. se reserva el dominio de la mercancía entregada hasta no haber satisfecho el cliente la totalidad de su importe.

PORTES

1. Los pedidos de productos en condiciones P.V.P.R. de tarifa y descuentos especiales acordados en cada caso, cuyo importe supere los 300 € se enviarán a portes pagados a cualquier punto de la Península y Baleares, excepto precios y productos especiales (consultar). Para envíos a Canarias, Ceuta y Melilla consulte a su delegado de zona, al dpto. comercial en el 96 280 04 04 o comercial@tecatel.com.
2. Todos los pedidos serán enviados a través de las agencias de transporte concertadas por Tecatel, S.L. Los portes de envíos urgentes o por cualquier otra agencia de transporte solicitada por el cliente, se realizarán siempre a cargo de éste, y deberá concertar la recogida con Tecatel, S.L.
3. **MUY IMPORTANTE:** La mercancía viaja asegurada por la agencia de transporte. Es requisito indispensable para cualquier reclamación de daños o merma de producto, que la reclamación se realice en presencia del transportista y se haga constar en el parte de entrega de la agencia de transporte que deberá estar firmado por el cliente. La incidencia deberá comunicarla a Tecatel, S.L. dentro de las 24 horas siguientes a la recepción.

RECUERDE: Si firma la recepción de la mercancía sin hacer constar la incidencia en el parte de transporte, la compañía de seguros no podrá comunicarla a Tecatel, S.L. dentro de las 24 horas siguientes a la recepción de la mercancía.

4. Tecatel S.L. se reserva el derecho de realizar la entrega de las referencias y cantidades del pedido en uno o varios envíos. Los posibles retrasos en la entrega no podrán ser motivo de indemnización.

CONDICIONES GENERALES DE VENTA

REPARACIONES, POSTVENTA, DEVOLUCIONES

- 1 Reparaciones: el cliente tiene derecho a solicitar un presupuesto detallado, cuyo coste de elaboración debe ser abonado en caso de no aceptarlo.
2. MUY IMPORTANTE: Indique de forma detallada los síntomas de la avería. Con ello, se evitarán costes y retrasos innecesarios en su reparación.
3. Tecatel, S.L. no aceptará la recepción de la mercancía que no cumpla nuestra normativa de Autorización de Devolución de Material y Postventa (RMA). Para más información, consulte las condiciones generales de postventa en www.tecatel.com o diríjase a rma@tecatel.com
4. Devoluciones: No se aceptará ninguna devolución de mercancía pasados 7 días desde su recepción por parte del cliente.
5. La mercancía objeto de este apartado viajará siempre por cuenta y riesgo del cliente.

CONDICIONES DE PAGO

La facturación y condiciones de pago estarán reflejadas en cada factura y albarán de entrega, siempre en base a la legislación vigente y a las condiciones pactadas con el cliente. Cualquier demora en la fecha de pago será objeto de una factura adicional con el cómputo de intereses y gastos bancarios ocasionados.

GARANTÍA











Todos los productos vendidos por Tecatel, S.L. en España están sometidos a las condiciones exigidas en la legislación vigente sobre garantías en la venta de bienes de consumo, significando que cualquier alteración, cambio o manipulación de software de fábrica o de componentes electrónicos o mecánicos de cualquier aparato será de responsabilidad exclusiva del comprador a cualquier efecto, y quedará invalidada la garantía del producto.

JURISDICCIÓN















Para cualquier cuestión relacionada con el incumplimiento de estas condiciones, las partes, con renuncia expresa a su propio fuero se someterán a los juzgados y tribunales del domicilio social de Tecatel, S.L.

**Tecatel, S.L. no se responsabiliza de posibles cambios o errores tipográficos aparecidos en esta tarifa y con el fin de mejorar la gestión, se advierte que los precios, así como las características pueden ser no acordes con la descripción, datos o imagen, y pueden ser modificados, por lo que es necesario consultar con el departamento comercial antes de tomar una decisión sobre cualquier producto.*

TV SATÉLITE

CÓDIGO	DESCRIPCIÓN		EMBAL.	€/UD
Antenas Parabólicas				
K60C1	Antena parabólica 60x54 cm mod. C	 FICHA TÉCNICA	1	31,74 €
K60C10	Antena parabólica 60x54 cm mod. C	 FICHA TÉCNICA	10	30,43 €
K60C1LSW	Kit Parabólica 60 cm, Soporte y LNB Universal	 FICHA TÉCNICA	40	45,11 €
K60C1LSCC	Kit antena 60cm, LNB, PP-30, cable y conectores	 FICHA TÉCNICA	40	43,42 €
K60C2LS	Kit 2 antenas 60 con 2 LNBs , 2 PP-30B - emp. indiv.	 FICHA TÉCNICA	40	60,43 €
K60C2LSCC	Kit 2 antenas 60cm,2 LNBs, 2 PP-30, dos cable (25m) y 4 conectores	 FICHA TÉCNICA	40	86,74€
K60C210	Kit antenas 60 MODELOS C embalaje industrial	 FICHA TÉCNICA	210	21,63 €
K65B10	Antena parabólica 65x60 cm mod. B	 FICHA TÉCNICA	10	33,04 €
K80A6	Antena parabólica 80x71 cm mod. A	 FICHA TÉCNICA	6	51,63 €
K80C1	Antena parabólica 80x71 cm mod. C	 FICHA TÉCNICA	1	58,70 €
K80C1LS	Kit antena 80 CON LNB Y PP-35 - emp. indiv.	 FICHA TÉCNICA	23	69,89 €
K80C1LSCC	Kit antena 80cm, LNB, PP-35, cable y conectores	 FICHA TÉCNICA	23	73,37 €
K80C2	Antena parabólica 80x71 cm mod. C	 FICHA TÉCNICA	2	53,80 €
K80C20	Antena parabólica 80x71 cm mod. C	 FICHA TÉCNICA	20	59,78 €
K85C1	Antena parabólica 85x80 cm mod. C	 FICHA TÉCNICA	1	79,57 €
K85C2	Antena parabólica 85x80 cm mod. C	 FICHA TÉCNICA	2	78,26 €
K85C20	Antena parabólica 85x80 cm mod. C	 FICHA TÉCNICA	20	59,78 €
K100C20	Antena parabólica 100x90 cm mod. C	 FICHA TÉCNICA	20	85,87€
K110P24	Antena parabólica 110x100 cm mod. PRO	 FICHA TÉCNICA	24	89,13 €
K120P24	Antena parabólica 120x100 cm mod. PRO	 FICHA TÉCNICA	24	136,96 €
Serigrafía				
PANTALLA	Pantalla		1	199,85 €
SERIGRAFÍA	Serigrafía		100	3,24 €

TV SATÉLITE

CÓDIGO	DESCRIPCIÓN		EMBAL.	€/UD
Soportes de suelo				
PS-60/850	Soporte suelo, Ø60, largo 850, para antenas de 110 y 120 cm	 FICHA TÉCNICA	1	64,57 €
PS-70/850	Soporte suelo, Ø70, largo 850, para antenas de 135 cm	 FICHA TÉCNICA	1	104,67 €
PSP-50	Soporte suelo/pared, Ø50, para antenas de 110 y 120 cm	 FICHA TÉCNICA	1	19,89 €
PSP-70	Soporte suelo/pared, Ø70, para antenas de 135 cm	 FICHA TÉCNICA	1	40,43 €
PSP-ART50	Soporte suelo/pared articulado, Ø50, para antenas de 110 y 120 cm	 FICHA TÉCNICA	1	44,29 €
Soportes de pared				
PP-30	Soporte pared en L para antenas de 60	 FICHA TÉCNICA	1	6,68 €
PP-35	Soporte pared en U para antenas de 60, 65 y 80	 FICHA TÉCNICA	1	11,96 €
PPL-35/240	Soporte pared en L, 35/ 240, para antenas de 60 y 65	 FICHA TÉCNICA	1	7,50 €
PPL-35/340	Soporte pared en L, 35/ 340, para antenas de 60 y 65	 FICHA TÉCNICA	1	8,37 €
PP-40	Soporte pared en L para antenas de 80 a 100	 FICHA TÉCNICA	1	28,80 €
PP-60	Soporte pared en L para antenas de 85 a 120	 FICHA TÉCNICA	1	87,66 €
PP-60/1500	Soporte pared recto para antenas de 85 a 120, con argollas	 FICHA TÉCNICA	1	75,60 €
PP-70	Soporte pared en L para antenas de 135	 FICHA TÉCNICA	1	82,17 €
PP-70/1500	Soporte pared recto para antenas de 135, con argollas	 FICHA TÉCNICA	1	89,24 €

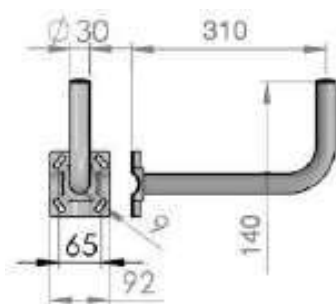

PP-30

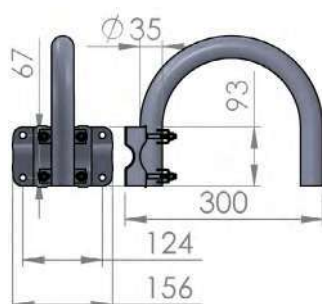

PP-35

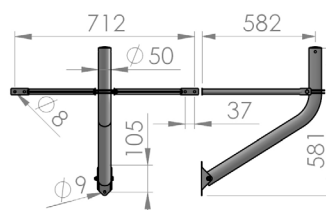













PSP-50



K60C1

TV SATÉLITE

CÓDIGO	DESCRIPCIÓN		EMBAL.	€/UD
LNB				
LNB-ILLULTRA5	LNB Illusion single Ultra 5, 1 sal. universal		1	5,33 €
LNB-ILLQUADPLAT3	LNB Illusion quad Platinum 3, 4 sal. universales		1	23,10 €
LNB-ILLTWINPLAT3	LNB Illusion twin Platinum 3, 2 sal. universales		1	16,25 €
LNB-ILL4UNIPLAT3	LNB Illusion quattro Platinum 3, 4 pol. SMATV colectivas		1	19,73 €
LNB-ILL8PLAT3	LNB Illusion octo Platinum, 8 sal. universales		1	57,12 €
LNB-DUOTWIN/2	LNB duo twin 19.2 - 23.5 4.3°, 2 sal. universales		1	67,93 €
LNB-IBU4/2	LNB Inverto quattro black ultra HGLN		1	37,50 €
LNB-IBUQUAD/2	LNB Inverto quad black ultra HGLN		1	53,15 €
LNB-IBUS/2	LNB Inverto single black ultra HGLN		1	15,98 €
LNB-IBUTW/2	LNB Inverto twin black ultra HGLN		1	35,11 €
LNB-IFLS	LNB Inverto single Flange, 1 sal. universal		1	12,66 €
LNB-INP4	LNB Inverto Quattro New Premium		1	23,26 €
LNB-INPQUAD	LNB Inverto quad New Premium		1	36,85 €
LNB-INPS	LNB Inverto single New Premium		1	8,48 €
LNB-INPTW	LNB Inverto twin New Premium		1	24,95 €
LNB-INV SINGLE	LNB Invacom single prime focus 0.3dB		1	65,76 €
LNB-WIDEBAND	LNB Wideband 40mm LNB Horizontal/Vertical		1	32,61 €



LNB-ILLULTRA5



LNB-ILLTWINPLAT3







LNB-ILL8PLAT3



LNB-IBUQUAD/2

TV SATÉLITE

CÓDIGO	DESCRIPCIÓN		EMBAL.	€/UD
Monoblock				
LNB-ILLMQ6HQ2	LNB Illusion monoblock quad 6°, 4 sal. universales		1	69,18 €
LNB-ILLMS6HQ2	LNB Illusion monoblock single 6°, 1 sal. universal		1	22,01 €
LNB-ILLMT6HQ2	LNB Illusion monoblock twin 6°, 2 sal. universales		1	46,74 €
LNB unicable				
LNB-OPTSCR8/2LP	LNB Unicable SCR 8 + 2 Legacy Ports		1	90,05 €
Multi LNB				
MULTI-LNB	Soporte 2 LNB ASTRA&EUTELSAT ant. hasta 120 cm		1	6,52 €
MULTI-LNB2	Soporte 2 LNB ASTRA&EUTELSAT ant. 135 cm		1	11,96 €
Conmutadores DiSEqC				
CONM-TEC4SN	Conmutador Tecatel DiSEqC 2.0, 4 ent.		1	6,30 €



CONM-TEC4SN



LNB-ILLMQ6HQ2

















LNB-OPTSCR8/2LP



MULTI-LNB

ANTENAS Y SOPORTES

CÓDIGO	DESCRIPCIÓN		EMBAL.	€/UD
Antenas terrestres				
ANT-BKM15700	Antena BKM triple plegable UHF G=15 dB ,LTE 700, naranja	 FICHA TÉCNICA	10	43,26 €
ANT-BKM18700	Antena BKM triple plegable, UHF G=18 dB LTE 700, naranja	 FICHA TÉCNICA	12	44,78 €
ANT-BKM18B700	Antena BKM triple plegable, UHF G=18 dB LTE 700, negra	 FICHA TÉCNICA	12	44,78 €
ANT-MINIHD700	Antena UHF mini HD G=13 dB LTE 700	 FICHA TÉCNICA	10	26,96 €
ANT-TCFM	Antena FM Tecatel (88-108MHz) omnidireccional	 FICHA TÉCNICA	1	26,30 €
ANT-LOG28F700	Antena logarítmica 28 elementos ganancia 12 dB, LT		1	41,52 €
Soportes y mástiles				
SC-01	Sujeta cable acero 1/4	 FICHA TÉCNICA	1	0,87 €
ST-01	Soporte teja	 FICHA TÉCNICA	1	23,70 €
TC-01	Tensor cable acero 1/4 6 mm	 FICHA TÉCNICA	1	3,04 €
TC-02	Tensor cable acero 1/4 8 mm	 FICHA TÉCNICA	1	4,89 €
TCA-01	Tensor de carraca	 FICHA TÉCNICA	1	1,25 €
TP0-ABARCON	Abarcon sujeta mástil para chimenea	 FICHA TÉCNICA	1	30,43 €
TP01720	Juegos de vientos para mástil	 FICHA TÉCNICA	1	3,26 €
TP01772	Garra escuadra pletina perfil 120 mm	 FICHA TÉCNICA	1	4,89 €
TP01764	Garra empotrar perfil L 500 mm	 FICHA TÉCNICA	1	8,15 €
TP01780	Garra base tacos perfil L 200 mm	 FICHA TÉCNICA	1	7,07 €

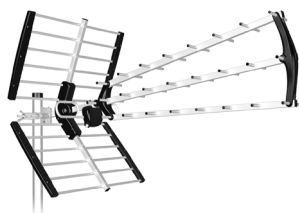

ANT-BKM18B700





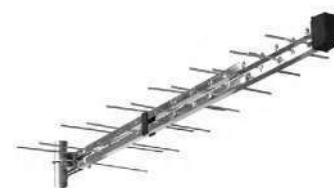

















ANT-BKM18700























ANT-LOG28F700







ANTENAS Y SOPORTES

CÓDIGO	DESCRIPCIÓN		EMBAL.	€/UD
Soportes y mástiles				
TP01783	Garra base tacos perfil L 300 mm	 FICHA TÉCNICA	1	9,24 €
TP01785	Garra base tacos perfil L 500 mm	 FICHA TÉCNICA	1	12,28€
TP01850	Abrazadera herradura M6	 FICHA TÉCNICA	1	1,90 €
TP01851	Abrazadera herradura M8	 FICHA TÉCNICA	1	2,50 €
TP01852	Abrazadera herradura M8 60 x 150	 FICHA TÉCNICA	1	3,04 €
TP01853	Abrazadera Galvanizada 35 mm M11		1	3,42 €
TP01723	Cable vientos acerado 2 mm	 FICHA TÉCNICA	1	0,40 €
TP1004	Cable vientos acerado 4 mm	 FICHA TÉCNICA	1	1,47€
TP1004INOX	Cable vientos inox. 4 mm	 FICHA TÉCNICA	1	1,90 €
TP1006	Cable vientos acerado 6 mm	 FICHA TÉCNICA	1	1,90 €
TP01302	Mástil galvanizado enchufable 1500x35x1.5 mm	 FICHA TÉCNICA	6	14,08 €
TP01309	Mástil galvanizado enchufable 2500x35x1.5 mm	 FICHA TÉCNICA	6	23,86 €
TP01310	Mástil galvanizado enchufable 3000x35x1.5 mm	 FICHA TÉCNICA	6	27,12 €
Torretas				
TP-1802	Torreta tramo superior 1500x180 mm	 FICHA TÉCNICA	1	107,61 €
TP-1804	Torreta tramo superior 2500x180 mm	 FICHA TÉCNICA	1	152,17 €
TP-1803	Torreta tramo intermedio 2500x180 mm	 FICHA TÉCNICA	1	125,00 €
TP-1802R	Torreta tramo superior 1500x180 mm., reforzado, rosca	 FICHA TÉCNICA	1	141,30 €
TP-1803R	Torreta tramo superior 2500x180 mm., reforzado, rosca	 FICHA TÉCNICA	1	171,74 €
TP-1804R	Torreta tramo intermedio 2500x180 mm., reforzado, rosca	 FICHA TÉCNICA	1	176,63 €
TPB-180G	Base fija con garras para torre 180	 FICHA TÉCNICA	1	34,78 €
TPB-180	Base para torre 180 sin garras	 FICHA TÉCNICA	1	27,17 €
TPB-180A	Base abatible para torre 180	 FICHA TÉCNICA	1	59,02 €
TPB-180P	Base a pared para torre 180	 FICHA TÉCNICA	1	90,11 €
TPB-180GR	Base reforzada con garras para torre 180	 FICHA TÉCNICA	1	58,80 €
TPB-180R	Base para torre 180 reforzada sin garras	 FICHA TÉCNICA	1	47,93 €
TPB-180AR	Base abatible para torre 180 reforzada	 FICHA TÉCNICA	1	101,09 €

AMPLIFICACIÓN

CÓDIGO	DESCRIPCIÓN		EMBAL.	€/UD
Interior				
AMP-LTE30TECAL	Amplificador int. Tecatel 30dB, 100 dB μ V LTE 700		1/10	22,17 €
AMP-LTE24TECAL	Amplificador int. Tecatel 24dB, 103 dB μ V LTE 700		1/10	23,04 €
AMP-LTE24ATBL	Amplificador int. Tecatel, toda banda, LTE 700		1/10	30,87 €
TE-AS039T	Amplificador int. 2 sal., filtro integrado LTE 694MHz		1	55,00 €
TE-AS039R65	Amplificador int. 2 sal,20 dB,87-862 MHz, 100 dB μ V, V.R. 5-65 MHz		1	53,26 €
TE-HSA001	Amplificador int. RF+FI, 18/25 dB, 1 sal., 115 dB μ v		1	110,54 €
Mástil				
AMP-LTE304L	Amplificador mástil 30dB Tecatel, UHF, LTE 700		1	20,00 €
AMP-LTE305L	Amplificador mástil 30dB Tecatel, UHF-UHF LTE 700		1	20,54 €
AMP-LTE404L	Amplificador mástil 40dB Tecatel UHF, LTE 700		1	22,07 €
AMP-LTE403L	Amplificador mástil 40dB Tecatel, VHF-UHF, LTE 700		1	27,14 €
AMP-LTE405L	Amplificador mástil 40dB Tecatel, UHF-UHF LTE 700		1	22,72 €
Centrales multibanda				
TE-MA049T	Amplificador multibanda 3 entradas FM+VHFII+UHF, filtro integrado LTE 694MHz		1	134,78 €
TE-MA050T	Amplificador multibanda 2 entradas FM+VHFII+UHF, filtro integrado LTE 694MHz		1	111,30 €
TE-MA056T	Amplificador multibanda 4 entradas VHFII-FM-VHFIII,2xUHF,5V DC for external preamplifier, filtro integrado LTE 694MHz		1	133,70 €
TE-MA074T	Amplificador multibanda 5 entradas VHFIII+UHF, filtro integrado LTE 694MHz		1	178,59 €
TE-MA075T	Amplificador multibanda 3 entradas VHFIII+UHF, filtro integrado LTE 694MHz		1	142,39 €
TE-MA076T	Amplificador multibanda 4 entradas FM+VHFIII+2xUHF, filtro integrado LTE 694MHz		1	150,65 €
TE-HS004T	Amplificador multibanda 39-44 dB, 88-230MHz, 470-694MHz, 1 salida, ajuste pend., test en E/S, 121 dB μ V, filtro integrado LTE 694MHz		1	152,83 €
TE-HS005T	Amplificador multibanda, 30-34 dB, DIN45004B 115 dB μ , filtro integrado LTE 694MHz		1	125,11 €
TE-HS018T	Amplificador multibanda con ajuste separado VHF-UHF, 2 Salidas, filtro integrado LTE 694MHz		1	72,93 €
AMP-MB50FIL	Central amplificación, 5 ent. / 1 sal., FI, 45 dB LTE 700		1	122,83 €
AMP-MB50L	Central amplificación, 50dB, 3 entradas, FM/VHF-III/UHF LTE 700		1	110,87 €

AMPLIFICACIÓN

CÓDIGO	DESCRIPCIÓN	EMBAL.	€/UD
FI			
AMP-FI500L	Amplificador FI Tecatel 35 dB, 13/18V, 0-22kHz, LTE 700 	1	68,48 €
RF + FI			
TE-HSA100	Amplificador de cabecera/línea RF+FI, 24/31 dB, 120 dBμV 	1	193,80 €
TE-HSA100R65	Amplificador de cabecera/línea RF+FI, 24/31 dB, 120 dBμv, V.R. 5-65 MHz 	1	219,78 €
Fuentes de alimentación			
FA-MAX24160C	Fuente de alimentación Tecatel 24V, 160mA, 2 sal. 	1/50	15,00 €
FA-MAX24250	Fuente de alimentación mini Tecatel 24V, 250mA 	1/100	15,60 €
TE-UP410S	Fuente de alimentación monocanal mezcla, 47-2400 MHz, 12V 4.5A 	1	279,46 €



AMP-FI500L



AMP-LTE24TECAL

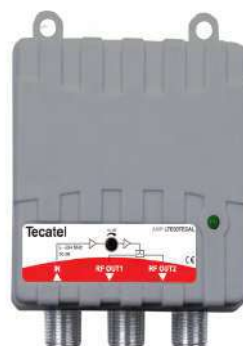

AMP-LTE30TECAL



AMP-LTE403L



FA-MAX24250



TE-UP410S



























FA-MAX24160C



TF-HSA100

















ICT - PASIVOS - TOMAS TV

CÓDIGO	DESCRIPCIÓN		EMBAL.	€/UD
Repartidores				
REP-CLA2S	Repartidor serie Class A 5-2400 MHz 2 sal.	 FICHA TÉCNICA	1	4,57 €
REP-CLA3S	Repartidor serie Class A 5-2400 MHz 3 sal.	 FICHA TÉCNICA	1	5,00 €
REP-CLA4S	Repartidor serie Class A 5-2400 MHz 4 sal.	 FICHA TÉCNICA	1	6,41 €
REP-CLA6S	Repartidor serie Class A 5-2400 MHz 6 sal.	 FICHA TÉCNICA	1	8,15 €
REP-CLA8S	Repartidor serie Class A 5-2400 MHz 8 sal.	 FICHA TÉCNICA	1	8,80 €
REP-SM2S	Repartidor serie Smart 5-2400 MHz 2 sal.		1	3,04 €
REP-SM4S	Repartidor serie Smart 5-2400 MHz 4 sal.		1	4,46 €
REP-SM6S	Repartidor serie Smart 5-2400 MHz 6 sal.		1	7,61 €
REP-SM8S	Repartidor serie Smart 5-2400 MHz 8 sal.		1	8,70 €
REP-TIP2S	Repartidor serie TIP 5-2400 MHz 2 sal.	 FICHA TÉCNICA	1	7,39 €
REP-TIP3S	Repartidor serie TIP 5-2400 MHz 3 sal.	 FICHA TÉCNICA	1	7,61 €
REP-TIP4S	Repartidor serie TIP 5-2400 MHz 4 sal.	 FICHA TÉCNICA	1	11,41 €
REP-IECT	Repartidor 2 sal. IEC en T, 5-1000 MHz		1	1,96 €
Derivadores				
DER-CLA1S10	Derivador serie Class A 1 sal. 10 dB	 FICHA TÉCNICA	1	4,13 €
DER-CLA1S15	Derivador serie Class A 1 sal. 15 dB	 FICHA TÉCNICA	1	4,13 €
DER-CLA1S20	Derivador serie Class A 1 sal. 20 dB	 FICHA TÉCNICA	1	4,13 €
DER-CLA1S25	Derivador serie Class A 1 sal. 25 dB	 FICHA TÉCNICA	1	4,13 €
DER-CLA2S10	Derivador serie Class A 2 sal. 10 dB	 FICHA TÉCNICA	1	4,89 €
DER-CLA2S15	Derivador serie Class A 2 sal. 15 dB	 FICHA TÉCNICA	1	4,89 €
DER-CLA2S20	Derivador serie Class A 2 sal. 20 dB	 FICHA TÉCNICA	1	4,89 €
DER-CLA2S25	Derivador serie Class A 2 sal. 25 dB	 FICHA TÉCNICA	1	4,89 €
DER-CLA4S12	Derivador serie Class A 4 sal. 12 dB	 FICHA TÉCNICA	1	6,09 €
DER-CLA4S15	Derivador serie Class A 4 sal. 15 dB	 FICHA TÉCNICA	1	6,09 €
DER-CLA4S20	Derivador serie Class A 4 sal. 20 dB	 FICHA TÉCNICA	1	6,09 €
DER-CLA4S25	Derivador serie Class A 4 sal. 25 dB	 FICHA TÉCNICA	1	6,09 €
DER-CLA6S15	Derivador serie Class A 6 sal. 15 dB	 FICHA TÉCNICA	1	8,42 €
DER-CLA6S20	Derivador serie Class A 6 sal. 20 dB	 FICHA TÉCNICA	1	8,42 €
DER-CLA6S25	Derivador serie Class A 6 sal. 25 dB	 FICHA TÉCNICA	1	8,42 €
DER-CLA8S15	Derivador serie Class A 8 sal. 15 dB	 FICHA TÉCNICA	1	10,76 €
DER-CLA8S20	Derivador serie Class A 8 sal. 20 dB	 FICHA TÉCNICA	1	10,76 €

ICT - PASIVOS - TOMAS TV

CÓDIGO	DESCRIPCIÓN		EMBAL.	€/UD
Derivadores				
DER-CLA8S25	Derivador serie Class A 8 sal. 25 dB	 FICHA TÉCNICA	1	10,76 €
DER-SM1S10	Derivador serie Smart 5-2400 MHz 1 sal. 10 dB	 FICHA TÉCNICA	1	3,37 €
DER-SM1S14	Derivador serie Smart 5-2400 MHz 1 sal. 14 dB	 FICHA TÉCNICA	1	3,37€
DER-SM1S18	Derivador serie Smart 5-2400 MHz 1 sal. 18 dB	 FICHA TÉCNICA	1	3,37 €
DER-SM1S22	Derivador serie Smart 5-2400 MHz 1 sal. 22 dB	 FICHA TÉCNICA	1	3,37 €
DER-SM2S10	Derivador serie Smart 5-2400 MHz 2 sal. 10 dB	 FICHA TÉCNICA	1	4,02 €
DER-SM2S14	Derivador serie Smart 5-2400 MHz 2 sal. 14 dB	 FICHA TÉCNICA	1	4,02 €
DER-SM2S18	Derivador serie Smart 5-2400 MHz 2 sal. 18 dB	 FICHA TÉCNICA	1	4,02 €
DER-SM2S22	Derivador serie Smart 5-2400 MHz 2 sal. 22 dB	 FICHA TÉCNICA	1	4,02 €
DER-SM2S26	Derivador serie Smart 5-2400 MHz 2 sal. 26 dB	 FICHA TÉCNICA	1	4,02 €
DER-SM2S30	Derivador serie Smart 5-2400 MHz 2 sal. 30 dB	 FICHA TÉCNICA	1	4,02 €
DER-SM4S12	Derivador serie Smart 5-2400 MHz 4 sal. 12 dB	 FICHA TÉCNICA	1	4,78 €
DER-SM4S14	Derivador serie Smart 5-2400 MHz 4 sal. 14 dB	 FICHA TÉCNICA	1	4,78 €
DER-SM4S18	Derivador serie Smart 5-2400 MHz 4 sal. 18 dB	 FICHA TÉCNICA	1	4,78 €
DER-SM4S22	Derivador serie Smart 5-2400 MHz 4 sal. 22 dB	 FICHA TÉCNICA	1	4,78 €
DER-SM4S26	Derivador serie Smart 5-2400 MHz 4 sal. 26 dB	 FICHA TÉCNICA	1	4,78 €
DER-SM4S30	Derivador serie Smart 5-2400 MHz 4 sal. 30 dB	 FICHA TÉCNICA	1	4,78 €
DER-SM6S16	Derivador serie Smart 5-2400 MHz 6 sal. 16 dB	 FICHA TÉCNICA	1	7,07 €
DER-SM6S20	Derivador serie Smart 5-2400 MHz 6 sal. 20 dB	 FICHA TÉCNICA	1	7,07 €
DER-SM6S25	Derivador serie Smart 5-2400 MHz 6 sal. 25 dB	 FICHA TÉCNICA	1	7,07 €
DER-SM6S30	Derivador serie Smart 5-2400 MHz 6 sal. 30 dB	 FICHA TÉCNICA	1	7,07 €
DER-SM8S16	Derivador serie Smart 5-2400 MHz 8 sal. 16 dB	 FICHA TÉCNICA	1	9,24 €
DER-SM8S20	Derivador serie Smart 5-2400 MHz 8 sal. 20 dB	 FICHA TÉCNICA	1	9,24 €
DER-SM8S30	Derivador serie Smart 5-2400 MHz 8 sal. 30 dB	 FICHA TÉCNICA	1	9,24 €
DER-TIP1S10	Derivador serie TIP 1 sal. 10 dB	 FICHA TÉCNICA	1	6,41 €
DER-TIP1S15	Derivador serie TIP 1 sal. 15 dB	 FICHA TÉCNICA	1	6,41 €
DER-TIP1S20	Derivador serie TIP 1 sal. 20 dB	 FICHA TÉCNICA	1	6,41 €
DER-TIP1S25	Derivador serie TIP 1 sal. 25 dB	 FICHA TÉCNICA	1	6,41 €
DER-TIP2S10	Derivador serie TIP 2 sal. 10 dB	 FICHA TÉCNICA	1	6,96 €
DER-TIP2S15	Derivador serie TIP 2 sal. 15 dB	 FICHA TÉCNICA	1	6,96 €

ICT - PASIVOS - TOMAS TV

CÓDIGO	DESCRIPCIÓN		EMBAL.	€/UD
Derivadores				
DER-TIP2S20	Derivador serie TIP 2 sal. 20 dB	 FICHA TÉCNICA	1	6,96 €
DER-TIP2S25	Derivador serie TIP 2 sal. 25 dB	 FICHA TÉCNICA	1	6,96 €
DER-TIP4S12	Derivador serie TIP 4 sal. 12 dB	 FICHA TÉCNICA	1	9,46 €
DER-TIP4S15	Derivador serie TIP 4 sal. 15 dB	 FICHA TÉCNICA	1	9,46 €
DER-TIP4S20	Derivador serie TIP 4 sal. 20 dB	 FICHA TÉCNICA	1	9,46 €
DER-TIP4S25	Derivador serie TIP 4 sal. 25 dB	 FICHA TÉCNICA	1	9,46 €
PAUs				
PAU-CLA2S	Punto acceso usuario 2 salidas, 5-2400 MHz CLASS A	 FICHA TÉCNICA	1	3,15 €
PAU-CLA3S	Punto acceso usuario 3 salidas, 5-2400 MHz CLASS A	 FICHA TÉCNICA	1	4,18 €
PAU-CLA4S	Punto acceso usuario 4 salidas, 5-2400 MHz CLASS A	 FICHA TÉCNICA	1	7,17 €
PAU-CLA5S	Punto acceso usuario 5 salidas, 5-2400 MHz CLASS A	 FICHA TÉCNICA	1	10,33 €
PAU-CLA6S	Punto acceso usuario 6 salidas, 5-2400 MHz CLASS A	 FICHA TÉCNICA	1	11,09 €
PAU-CLA8S	Punto acceso usuario 8 salidas, 5-2400 MHz CLASS A	 FICHA TÉCNICA	1	11,20 €
Tomas TV				
TF-02	Toma final 2 sal. TV-SAT, paso DC	 FICHA TÉCNICA	1	5,76 €
TI-0502	Toma intermedia 5 dB 2 sal. TV-SAT	 FICHA TÉCNICA	1	6,30 €
TI-1002	Toma intermedia 10 dB 2 sal. TV-SAT, paso DC	 FICHA TÉCNICA	1	6,30 €
TI-1402	Toma intermedia 14 dB 2 sal. TV-SAT, paso DC	 FICHA TÉCNICA	1	6,30 €
TI-1802	Toma intermedia 18 dB 2 sal. TV-SAT, paso DC	 FICHA TÉCNICA	1	6,30 €
TBA-01	Base de plástico de superficie para tomas de TV		1	1,25€
TCP-02	Carátula para tomas de 2 sal. Tecatel		1	1,30 €
TCP-02A	Caratula para toma de 2 salidas		1	1,63 €



DER-TIP2S20

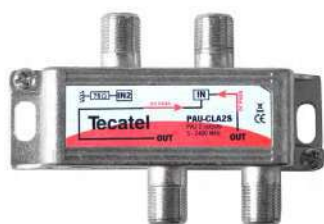

PAU-CLA2S





TCP-02



TF-02

ICT - PASIVOS - TOMAS TV

CÓDIGO	DESCRIPCIÓN		EMBAL.	€/UD
Rosetas				
ICT-RO1C6	Roseta de superficie 1RJ45 Cat. 6	 FICHA TÉCNICA	1	3,04 €
ICT-RO2C6	Roseta de superficie 2RJ45 Cat. 6	 FICHA TÉCNICA	1	4,18 €
Multiplexor				
ICT-MUX8B	Multiplexor pasivo 8 puertos RJ45, Blindado, Cat. 6	 FICHA TÉCNICA	1	17,72 €
Latiguillos				
ICT-UTP6L05	Latiguillo UTP Cat. 6, Cu, RJ45, LSZH, 0.5m	 FICHA TÉCNICA	1	2,23 €
ICT-UTP6L1	Latiguillo UTP Cat. 6, Cu, RJ45, LSZH, 1 m	 FICHA TÉCNICA	1	2,93€
ICT-UTP6L2	Latiguillo UTP Cat. 6, Cu, RJ45, LSZH, 2 m	 FICHA TÉCNICA	1	4,35 €
ICT-UTP6L3	Latiguillo UTP Cat. 6, Cu, RJ45, LSZH, 3 m	 FICHA TÉCNICA	1	5,22 €
ICT-UTP6L5	Latiguillo UTP Cat. 6, Cu, RJ45, LSZH, 5 m	 FICHA TÉCNICA	1	5,54 €
ICT-UTP6L10	Latiguillo UTP Cat. 6, Cu, RJ45, LSZH, 10 m	 FICHA TÉCNICA	1	9,67 €
ICT-UTP6L15	Latiguillo UTP Cat. 6, Cu, RJ45, LSZH, 15 m	 FICHA TÉCNICA	1	11,41 €



ICT-MUX8B



ICT-RO1C6











ICT-RO2C6



ICT-UTP6L05

CABLES, CONECTORES Y HERRAMIENTAS

CÓDIGO	DESCRIPCIÓN	EMBAL.	€/UD
Cables coaxiales			
CAB-MK400BL	Cable coaxial MK 400 LSZH,CPR, Dca a2s2d2, 100 m, Blanco	100	0,908 €
CAB-MK400N	Cable coaxial MK 400 PE, 100m, Negro	100	0,870 €
CAB-PC100	Cable coaxial PC100 6.6 mm, 100 m, Blanco	100	0,336 €
CAB-GC100	Cable coaxial GC100 6.8 mm, 100 m, Blanco	100	0,808 €
Cables de datos UTP y FTP (Cat. 5E)			
CAB-UTP5B	Cable UTP Cat. - 5 PVC (Filtro UV) Interior-Exterior, Blanco, 305 m. CCA	 FICHA TÉCNICA	610 0,358 €
CAB-UTP5N	Cable UTP Cat.- 5E HDPE Interior-Exterior. Negro, 305 m, CCA	 FICHA TÉCNICA	610 0,340 €
CAB-FTP5N	Cable FTP Cat.- 5E HDPE Interior-Exterior. Negro, 305 m, CCA	 FICHA TÉCNICA	610 0,414 €
Cables de datos UTP y FTP (Cat. 6)			
CAB-UTP6N	Cable UTP Cat.- 6 HDPE ext. Negro, Interior-Exterior, EUROCLASS Fca, 305 m, CCA	 FICHA TÉCNICA	610 0,400 €
CAB-UTP6CUN	Cable UTP Cat.- 6 HDPE Interior-Exterior, Negro CPR EUROCLASS Fca, Cu	 FICHA TÉCNICA	610 1,084 €
CAB-UTP6LV	Cable UTP Cat.- 6 PVC LSZH (Filtro UV) Interior-Exterior, Euroclass Dca, Violeta, 305 m. CCA	 FICHA TÉCNICA	610 0,564 €
CAB-FTP6N	Cable FTP Cat.- 6 HDPE Interior-Exterior, Negro, Euroclass Fca, 305 m. CCA	 FICHA TÉCNICA	610 0,637 €
CAB-FTP6CUPEB	Cable FTP Cat.- 6, HDPE, Interior-Exterior, Euroclass Fca, blanco, 305 m, bobina roller, Cu	 FICHA TÉCNICA	610 1,223 €
CAB-FTP6CUN	Cable FTP Cat.- 6 HDPE Interior-Exterior, Negro, Euroclass Fca, 305 m., Cu	 FICHA TÉCNICA	610 1,000 €



CAB-FTP6N



CAB-MK400BL





CAB-UTP5B



CAB-UTP6LV

CABLES, CONECTORES Y HERRAMIENTAS

CÓDIGO	DESCRIPCIÓN	EMBAL.	€/UD
Conectores			
CON-ALQ59N	Conector F rosca para cable RG6 de 6,4mm	100	0,20 €
CON-ALQ59RAP	Conector F rápido rosca para cable RG6 de 6.4mm	100	0,76 €
CON-DCBLOCK	Conector F para bloqueo de corriente continua 	10	1,58 €
CON-FCABRG6	Conector Cabelcon F CRIMPAR para cable RG6	100	1,36 €
CON-F01C	Conector Tecatel F de compresión para cable RG6	1	1,03 €
CON-FCARGA	Conector F carga cierre	100	0,42 €
CON-IECF	Conector IEC hembra acodado 9.52 cable RG6	100	0,49 €
CON-IECM	Conector IEC macho acodado 9.52 cable RG6	50	0,38 €
CON-IECHLTE	Conector IEC blindado hembra cable RG6, LTE	50	1,50 €
CON-IECMLTE	Conector IEC blindado macho cable RG6, LTE	50	1,58 €
CON-TIPCARGA	Conector carga 75 Ω para serie TIP	100	0,34 €
CON-IECH01C	Conector IEC Hembra de compresión, 4,5 mm	10	1,52 €
CON-IECM01C	Conector IEC Macho de compresión, 4,5 mm	10	1,58 €
Adaptadores			
CON-FH/H	Adaptador F hembra / hembra	100	0,38€
CON-FH/IECH	Adaptador F hembra / IEC hembra	100	0,61 €
CON-FH/IECM	Adaptador F hembra / IEC macho	100	0,54 €
CON-FM/M	Adaptador F macho / macho	100	0,75 €
CON-FRAPIDO	Adaptador F rápido	100	0,75 €
CON-IECH/H	Adaptador IEC hembra / hembra	100	0,77 €
Cables y accesorios			
CAB-HDMI201	Cable HDMI v2.0, macho/macho, 1 m 	1	3,15 €
CAB-HDMI205	Cable HDMI v2.0, macho/macho, 5 m 	1	6,63 €



CON-ALQ59N



CON-FH/H









CON-IECF



CON-TIPCARGA

CABLES, CONECTORES Y HERRAMIENTAS

CÓDIGO	DESCRIPCIÓN	EMBAL.	€/UD
Conectores de cables de datos			
CON-JACKRJ45	Conector RJ45 UTP Cat. 5 Macho 	100	0,22 €
CON-JACKRJ45B	Conector RJ45 UTP Cat. 5 Blindado Macho 	100	0,33 €
CON-RJ45C6	Conector RJ45 cable UTP Cat. 6 Macho 	100	0,34€
CON-RJ45C6H	Conector RJ45 Cat. 6 Hembra 	1	2,12 €
CON-RJ45R	Conector RJ45 Cat. 6 montaje rápido 	1	2,39 €
CON-RJ45C6AR	Conector RJ45 cat6A 8P8C montaje rápido sin herramienta 	1	5,33 €
CON-CAPUTP	Capuchón para conector RJ45	100	0,10 €
CON-RJ45C7	Conector RJ45 8P8C FTP/STP/SFTP Cat6/cat7 	100	1,58 €
CON-ADAPC6HH	Adaptador RJ45 HH Cat. 6	1	2,09 €
Fijación y accesorios de instalación			
CINTA1B	Cinta aislante blanca PVC 20 m x 1.9 cm x 0.15 mm	1	2,93 €
CINTA1N	Cinta aislante negra PVC 20 m x 1.9 cm x 0.15 mm	1	2,93 €
CINTAV	Cinta vulcanizada autosoldable 9.15x19x0.76 mm negra	1	14,67 €
FI-BR01B	Brida abrazadera nylon blanca 3,5x200 mm	100	0,05 €
FI-BR01N	Brida abrazadera nylon negra 3,6x200 mm	100	0,05 €
FI-BR02B	Brida abrazadera nylon blanca 4,8x430 mm	100	0,86 €
FI-BR02N	Brida abrazadera nylon negra 4,8x430 mm	100	0,86 €
FI-BR03B	Brida abrazadera nylon blanca 9x780 mm	100	0,84 €
FI-BR03N	Brida abrazadera nylon negra 9x780 mm	100	0,84 €
FI-BR04V	Brida abrazadera nylon verde 3,6x140 mm	100	0,03 €
FI-BR05V	Brida abrazadera nylon verde 4,8x190 mm	100	0,09 €
FI-TA01B	Taco poliamida blanco para fijación, brida nylon broca de 6 mm	100	0,08 €
FI-TA01N	Taco poliamida negro para fijación, brida nylon broca de 6 mm	100	0,08 €
FI-TA02B	Taco poliamida blanco para fijación, brida nylon broca de 8 mm	100	0,08 €
FI-TA02N	Taco poliamida negro para fijación, brida nylon broca de 8 mm	100	0,07 €
FI-TM10	Taco metálico, tornillo métrica 10 x 100 mm, broca de 12 mm	10	1,90 €
FI-TM12	Taco metálico, tornillo métrica 12 x 110 mm, broca de 16 mm	10	3,17 €
FI-TM6	Taco metálico, tornillo métrica 6 x 60 mm, broca de 9 mm	10	0,74 €
FI-TM8	Taco metálico, tornillo métrica 8 x 80 mm, broca de 10 mm	10	1,24 €

CABLES, CONECTORES Y HERRAMIENTAS

CÓDIGO	DESCRIPCIÓN	EMBAL.	€/UD
Fijación y accesorios de instalación			
FI-TME10	Taco metálico, espárrago métrica 10 x 100 mm, broca de 14 mm	10	2,00 €
FI-TME8	Taco metálico, espárrago métrica 8 x 80 mm, broca de 11 mm	10	1,24 €
TCMV	Taco metálico con argolla, vientos 8x60 mm, broca 11 mm	100	1,52 €
TCM-645	Taco metálico, tornillo métrica 6 x 45 mm, broca de 8 mm	10	0,60 €
TCM-860	Taco metálico, tornillo métrica 8 x 60 mm, broca de 11 mm	10	0,71 €
FI-GR01B	Grapa fijación abiertal RG6 reforzada blanca 7 mm	100	0,05 €
FI-GR01N	Grapa fijación abierta RG6 reforzada negra 7 mm	100	0,05 €
FI-GR02B	Grapa fijación cerrada RG6 blanca 7 mm	100	0,05 €
FI-GR02N	Grapa fijación cerrada RG6 negra 7 mm	100	0,05 €
FI-GR03B	Grapa fijación cable coaxial RG6 Blanca 7mm, Taco broca 4mm	100	0,08 €
FI-GR03N	Grapa fijación cable coaxial RG6 negra 7mm, Taco broca 4mm	100	0,08 €
FI-GR06B	Taco-Grapa para Coaxial RG6, color blanco	100	0,18 €
FI-GR07N	Grapa abierta fijación cable UTP negra 5 mm	100	0,04 €
Herramientas			
CON-PELCB	Herramienta pelacable y crimpar para cable de datos	1	19,46 €
CON-PELRG6	Herramienta pelacables para cable RG-6  FICHA TÉCNICA	1	3,23 €
CON-ALICOM	Alicates de compresión para conectores coaxiales RG6	1	59,08 €



CON-ALICOM



CON-PELCB





















FI-TME8



TCMV

MODULADORES Y TRANSMODULADORES

CÓDIGO	DESCRIPCIÓN		EMBAL.	€/UD
Filtros LTE, mezcladores y complementos				
FIL-LTE50EXT/2L	Filtro LTE 50 dB Tecatel F H/H ext. 694 MHz	 FICHA TÉCNICA	1	10,00 €
TE-TF001	Filtro LTE2 60 dB para exterior 5-694 MHz	 FICHA TÉCNICA	1	41,20€
TE-TF005	Filtro LTE2 50 dB para interior 5-694 MHz	 FICHA TÉCNICA	1	30,76 €
TE-TF006A	Filtro supresor LTE2 . Banda pasante 5-240, 470-694 MHz, supresión 703-3000MHz	 FICHA TÉCNICA	1	60,76 €
TE-TF007A	Filter for suppression of LTE signals.Pass band 5-240, 470-694 MHz, stop band 703-3000MHz	 FICHA TÉCNICA	1	74,89 €
AMP-LINFI	Amplificador FI Tecatel 35 dB, 13/18V, 0-22kHz, LTE	 FICHA TÉCNICA	1	5,00 €
AMP-LINRFFI	Amplificador de línea RF+FI Tecatel, 16-20 dB	 FICHA TÉCNICA	1	5,65 €
ATE-VAR20	Atenuador Tecatel RF+FI variable, 20 dB, con. F		1	7,50 €
MIX-TVSATCLA2	Mezclador TV-SAT SERIE CLASS A	 FICHA TÉCNICA	1	3,53 €
MIX-TVSATCLAEXT	Mezclador TV-SAT serie Class A para ext.		1	5,33 €
MIX-TVSATTIP	Mezclador TV-SAT serie TIP	 FICHA TÉCNICA	1	6,63 €
Moduladores digitales COFDM HD				
MOD-DIMHD8	Modulador Tecatel full HD COFDM ent-sal HDMI, USB, A/V in RCA	 FICHA TÉCNICA	1	304,35 €
TE-MHD001P	Modulador Terra DVB-T full HD, entrada HDMI	 FICHA TÉCNICA	1	242,93 €
TE-MHD002P	Modulador Terra DVB-T full HD, HDMI + Loop	 FICHA TÉCNICA	1	298,91 €
Transmodulación terra DVB-S/S2 y DVB-T/T2/C				
TE-tdx420	TransModulador doble DVB-S2 - DVB-T, FTA, 90 dBµV	 FICHA TÉCNICA	1	879,35 €
TE-tdx420C	TransModulador doble DVB-S2 - DVB-T, 2 C.I., 90 dBµV	 FICHA TÉCNICA	1	983,70 €
TE-ttx420	TransModulador doble DVB-T/T2 /C DVB/T	 FICHA TÉCNICA	100	975,20 €
TE-ttx420C	TransModulador doble DVB-T/T2/QAM - DVB-T, 2 C.I., 90 dBµV	 FICHA TÉCNICA	100	1.060,00 €
TE-tdx440	TransModulador ocho DVB-S2 - cuatro DVB-T	 FICHA TÉCNICA	100	1.279,67 €
TE-tdx480	TransModulador DVB-S2 - DVB-T, FTA, 90 dBµV	 FICHA TÉCNICA	100	2.391,30 €



AMP-LINFI



FIL-LTE50EXT/2L



























MOD-DIMHD8





TE-TF001

MODULADORES Y TRANSMODULADORES















CÓDIGO	DESCRIPCIÓN		EMBAL.	€/UD
Unicable				
TE-SRM522	Multiswitch activo cascad. unicable FI + terr (pasiva), ent. 300-2350 MHz, 2 derivaciones, 84 dBµV	 FICHA TÉCNICA	1	149,67 €
TE-SRM523	Multiswitch activo cascad. unicable FI + terr (pasiva), ent. 950-2150 MHz, 2 derivaciones, 84 dBµV	 FICHA TÉCNICA	1	213,04 €
TE-SRM524	Multiswitch activo cascad. unicable FI + terr (47-862 MHz), ent. 950-2150 MHz, 2 derivaciones (1 par), 84 dBµV, Alimentación desde líneas H/V	 FICHA TÉCNICA	1	213,59 €
TE-SRM543	Multiswitch activo cascad. unicable FI + terr (pasiva), ent. 950-2150 MHz, 4 derivaciones, 84 dBµV	 FICHA TÉCNICA	1	246,30 €
TE-SRM544	Multiswitch activo cascad. unicable FI + terr (47-862 MHz), ent. 290-2150 MHz, 4 derivaciones (2 pares), 84 dBµV, Alimentación desde líneas H/V	 FICHA TÉCNICA	1	294,13 €
TE-SRM564	Multiswitch activo cascad. unicable FI + terr (47-862 MHz), ent. 290-2150 MHz, 6 derivaciones (3 pares), 84 dBµV, Alimentación desde líneas H/V	 FICHA TÉCNICA	1	488,59 €
TE-SRM580	Multiswitch activo cascad. unicable FI + terr (pasiva), ent. 950-2150 MHz, 8 derivaciones, 84 dBµV	 FICHA TÉCNICA	1	475,54€
TE-SRM581	Multiswitch activo cascad. unicable FI + terr (pasiva), ent. 950-2150 MHz, 8 derivaciones, 84 dBµV	 FICHA TÉCNICA	1	485,00 €
TE-SRM584	Multiswitch activo cascad. unicable FI + terr (pasiva), ent. 290-2350 MHz, Terr. 47-862 MHz, 8 salidas (4 pares), Alimentación desde líneas H/V, 84 dBµV	 FICHA TÉCNICA	1	575,54 €
TE-SRM524T	Multiswitch activo cascad. unicable FI + terr (pasiva 47-862 MHz), ent. 290-2150 MHz, 1 derivaciones (1 par), 84 dBµV	 FICHA TÉCNICA	1	197,50 €
TE-SRM544T	Multiswitch activo cascad. unicable FI + terr (pasiva 5-862 MHz), ent. 290-2150 MHz, 4 derivaciones (2 pares), 84 dBµV	 FICHA TÉCNICA	1	289,02 €
TE-SRM564T	Multiswitch activo cascad. unicable FI + terr (pasiva 5-862 MHz), ent. 290-2150 MHz, 4 derivaciones (2 pares), 84 dBµV	 FICHA TÉCNICA	1	476,52 €
TE-SRM584T	Multiswitch activo cascad. unicable FI + terr (pasiva), ent. 290-2350 MHz, Terr. 5-862 MHz, 8 salidas (4 pares), Alimentación desde líneas H/V, 84 dBµV	 FICHA TÉCNICA	1	551,63 €
Accesorios				
TE-PS202F	Fuente de alimentación conmutada clic 20V 2A, conector F	 FICHA TÉCNICA	1	50,43 €
TE-PC102W	Programador multiswitches sistema unicable, con WIFI incorporado	 FICHA TÉCNICA	1	328,15 €
Mutiswitch terra 5 y 9				
TE-MR508	Multiswitch activo radial 4FI + terr, 8 sal., 93 dBµV	 FICHA TÉCNICA	1	211,20 €
TE-MR512	Multiswitch activo radial 4FI + terr, 12 sal., 93 dBµV	 FICHA TÉCNICA	1	248,37 €
TE-MR516	Multiswitch activo radial 4FI + terr, 16 sal., 93 dBµV	 FICHA TÉCNICA	1	329,89 €
TE-MR524	Multiswitch activo radial 4FI + terr, 24 sal., 93 dBµV	 FICHA TÉCNICA	1	522,61 €
TE-MR532	Multiswitch activo radial 4FI + terr, 32 sal., 93 dBµV	 FICHA TÉCNICA	1	673,04 €
TE-MR908L	Multiswitch activo radial 8FI + terr (A/P), 8 sal., 93 dBµV	 FICHA TÉCNICA	1	497,50 €
TE-MR912L	Multiswitch activo radial 8FI + terr (A/P), 12 sal., 93 dBµV	 FICHA TÉCNICA	1	620,43 €
TE-MR916L	Multiswitch activo radial 8FI + terr (A/P), 16 sal., 93 dBµV	 FICHA TÉCNICA	1	689,89 €
TE-MR924L	Multiswitch activo radial 8FI + terr (A/P), 24 sal., 93 dBµV	 FICHA TÉCNICA	1	829,02 €
TE-MR932L	Multiswitch activo radial 8Fli + terr (A/P), 32 sal., 93 dBµV	 FICHA TÉCNICA	1	959,13 €

MEDIDORES SMATV

CÓDIGO	DESCRIPCIÓN		EMBAL.	€/UD
Medidores				
SAT-FINDERTE	Apuntador satélite acústico con escala metrica	 FICHA TÉCNICA	1	10,33 €
M-TD24K	Medidor HD 265 4K Tecatel DVB-S, DVB-T, DVB-C+-DATOS+CCTV	 FICHA TÉCNICA	1	1.076,09 €

FIBRA ÓPTICA TECATEL

Tecatel

CÓDIGO	DESCRIPCIÓN		EMBAL.	€/UD
Conectores ópticos				
FO-060012	Conector de fibra óptica SC/APC FAST	 FICHA TÉCNICA	1	1,96
Adaptadores ópticos				
FO-060010	Adaptador FO SM SC/APC-SC/APC H-H Simplex panel, verde	 FICHA TÉCNICA	1	! 71
FO-060011	Adaptador FO SM SC/APC-SC/APC H-H Duplex panel, verde	 FICHA TÉCNICA	1	! 7
Pigtails				
FO-070007	Pigtail FO SM 9/125 SC/APC G657A2 0.9 mm LSZH 2 m	 FICHA TÉCNICA	1	#139
FO-070037	Pigtail FO SM 9/125 SC/APC G657A2 0.9 mm LSZH 1 m	 FICHA TÉCNICA	1	" 152
FO-070041	Pigtail FO SM 9/125 SC/APC G657A2 3 mm LSZH 20 m	 FICHA TÉCNICA	1	5198
FO-070060	Pigtail FO SM 9/125 SC/APC G657A2 3 mm LSZH 1 m	 FICHA TÉCNICA	1	168
FO-070086	Pigtail SC/APC exterior PE negro 30 m	 FICHA TÉCNICA	1	" 6163
FO-070087	Pigtail SC/APC exterior PE negro 60 m	 FICHA TÉCNICA	1	26130
FO-070089	Pigtail SC/APC exterior PE negro 100 m	 FICHA TÉCNICA	1	\$5149
Latiguillos				
FO-070058	Latiguillo FO SC/APC G657A2 3 mm, LSZH 1 m	 FICHA TÉCNICA	1	3148
FO-070065	Latiguillo FO SC/APC G657A2 3 mm, LSZH, 2 m	 FICHA TÉCNICA	1	\$125
FO-070068	Latiguillo FO SC/APC G657A2 3 mm, LSZH, 40 m	 FICHA TÉCNICA	1	21130
FO-070073	Latiguillo FO SC/APC G657A2 3 mm, LSZH, 3 m	 FICHA TÉCNICA	1	3191
FO-070074	Latiguillo FO SC/APC G657A2 3 mm, LSZH, 20 m	 FICHA TÉCNICA	1	(166



M-TD24K



SAT-FINDERTE



FO-060012



FO-070007













FIBRA ÓPTICA TECATEL

Tecatel

CÓDIGO	DESCRIPCIÓN		EMBAL.	€/UD
Spliters ópticos				
FO-070049	Splitter óptico PLC conectorizado SC/APC 1x2	 FICHA TÉCNICA	1	15,43 €
FO-070050	Splitter óptico PLC conectorizado SC/APC 1x4	 FICHA TÉCNICA	1	20,54 €
FO-070051	Splitter óptico PLC conectorizado SC/APC 1x8	 FICHA TÉCNICA	1	29,89 €
FO-070052	Splitter óptico PLC conectorizado SC/APC 1x16	 FICHA TÉCNICA	1	41,20 €
FO-070053	Splitter óptico PLC conectorizado SC/APC 1x32	 FICHA TÉCNICA	1	97,83 €
Torpedos				
FO-080012	Torpedo horizontal 2in/2out 12 fibras	 FICHA TÉCNICA	1	45,82 €
FO-080013	Torpedo horizontal 2in/2out 48 fibras	 FICHA TÉCNICA	1	48,64 €
FO-080014	Torpedo horizontal 2in/2out 96 fibras	 FICHA TÉCNICA	1	55,65 €
FO-080015	Torpedo horizontal 4in/4out 12 fibras	 FICHA TÉCNICA	1	61,79 €
FO-080016	Torpedo horizontal 4in/4out 48 fibras	 FICHA TÉCNICA	1	91,30 €
FO-080017	Torpedo horizontal 4in/4out 96 fibras	 FICHA TÉCNICA	1	72,45 €
FO-080018	Torpedo vertical 4in/4out 12 fibras	 FICHA TÉCNICA	1	40,92 €
FO-080019	Torpedo vertical 4in/4out 48 fibras	 FICHA TÉCNICA	1	47,34 €
FO-080020	Torpedo vertical 4in/4out 96 fibras	 FICHA TÉCNICA	1	74,18 €
Distribución				
FO-080001	Caja de superficie FO 1 SC FTTH	 FICHA TÉCNICA	1	1,52 €
FO-080002	Roseta óptica 2 SC FTTH	 FICHA TÉCNICA	1	1,14€
FO-080003	Caja de superficie FO 4 SC FTTH	 FICHA TÉCNICA	1	4,24 €
FO-080008	Caja de distribución FO 8 SC FTTH	 FICHA TÉCNICA	1	28,64 €
FO-080009	Caja de distribución FO 16 SC FTTH	 FICHA TÉCNICA	1	34,46 €
FO-080010	Caja de distribución FO 24 SC FTTH	 FICHA TÉCNICA	1	36,03 €
FO-080011	Caja de distribución FO 48 SC FTTH	 FICHA TÉCNICA	1	37,17 €
FO-080021	Caja de distribución FO 32 SC FTTH	 FICHA TÉCNICA	1	30,98 €
FO-090014	Registro principal FO 24 SC	 FICHA TÉCNICA	1	86,96 €
FO-090015	Registro principal FO 48 SC	 FICHA TÉCNICA	1	96,29 €











FIBRA ÓPTICA TECATEL

Tecatel

CÓDIGO	DESCRIPCIÓN		EMBAL.	€/UD
Conversores				
FO-100009	Módulos de expansión fibra óptica bidireccional emisor-Receptor ,TX1310nm RX1550nm (3km)	 FICHA TÉCNICA	1	104,87 €
FO-100010	Módulos de expansión fibra óptica bidireccional emisor-Receptor TX1310nm RX1550nm (20km)	 FICHA TÉCNICA	1	153,46€
FO-100011	Convertor de medios fibra óptica, emisor-Receptor 1 RJ45 100 Mbps 1SC (25km)	 FICHA TÉCNICA	1	112,53 €
FO-100014	Convertor de medios fibra óptica, emisor-Receptor 8 RJ45 100 Mbps 1SC (20km)	 FICHA TÉCNICA	1	187,73 €
FO-100016	Convertor pasivo FTTH/CATV, SC/APC-FM con filtro WDM	 FICHA TÉCNICA	1	10,24 €
FO-100018	Convertor pasivoFTTH/CATV SC/APC-FH blindado zamak	 FICHA TÉCNICA	1	9,09 €
Cables				
FO-130006	Cable de fibra óptica SM G657A2 LSZH 2 fibras	 FICHA TÉCNICA	1	a consultar
FO-130007	Cable de fibra óptica SM G657A2 LSZH 24 fibras	 FICHA TÉCNICA	1	a consultar
FO-130008	Cable de fibra óptica SM G657A2 LSZH 1 fibra	 FICHA TÉCNICA	1	a consultar
FO-130009	Cable de fibra óptica SM G657A2 LSZH 8 fibras	 FICHA TÉCNICA	1	a consultar
FO-130010	Cable de fibra óptica SM G657A2 LSZH 4 fibras	 FICHA TÉCNICA	1	a consultar
FO-130011	Cable de fibra óptica SM G657A2 LSZH 48 fibras	 FICHA TÉCNICA	1	a consultar
FO-130012	Cable de fibra óptica SM G657A2 LSZH 6 fibras	 FICHA TÉCNICA	1	a consultar
FO-130014	Cable de fibra óptica SM G657A2 LSZH 16 fibras		1	a consultar
FO-130015	Cable de fibra óptica MM 6 fibras 50/125, Int./Ext. LSZH, antioedores		1	a consultar
FO-130016	Cable de fibra óptica MM 8 fibras 50/125, Int./Ext. LSZH, antioedores		1	a consultar
FO-130017	Cable de fibra óptica MM 8 fibras 62,5/125, Int./Ext. LSZH, antioedores		1	a consultar
FO-130018	Cable de fibra óptica MM 8 fibras 50/125 ext. metálica CTS LSZH, antioedores		1	a consultar
FO-130019	Cable de fibra óptica MM 8 fibras 9/125 ext. metálica CTS LSZH, antioedores		1	a consultar
Equipos de medida				
FO-120003	Medidor de potencia de fibra óptica universal	 FICHA TÉCNICA	1	336,96 €
FO-120004	Láser localizador de fallos en fibra óptica	 FICHA TÉCNICA	1	84,78 €
FO-120006	Medidor de potencia óptica, especial FTTH	 FICHA TÉCNICA	1	483,70 €
FO-120007	Micro reflectómetro óptico (OTDR)	 FICHA TÉCNICA	1	2.913,04 €
FO-120009	Identificador de fibra óptica (detección señal/tráfico y sentido de la señal)	 FICHA TÉCNICA	1	674,88 €
FO-120011	Fuente de luz láser para fibra óptica, especial FTTH (1310/1490/1550nm) con pilas recargables	 FICHA TÉCNICA	1	510,87 €
FO-120012	Bobina lanzadera de fibra óptica para medidas con OTDR (500 m)	 FICHA TÉCNICA	1	918,48 €

FIBRA ÓPTICA TECATEL

Tecatel

CÓDIGO	DESCRIPCIÓN		EMBAL.	€/UD
Fusionadora				
FO-110001	Fusionadora de fibra óptica con alineación por núcleo	 FICHA TÉCNICA	1	2.771,74 €
Herramientas y accesorios				
FO-110002	Cortadora para fusionadora	 FICHA TÉCNICA	1	263,04 €
FO-110009	Bote para alcohol 200ml	 FICHA TÉCNICA	1	14,35 €
FO-110011	Toallas de limpieza de fibra óptica	 FICHA TÉCNICA	1	24,02 €
FO-110012	Lápiz limpiador de conectores SC/FC	 FICHA TÉCNICA	1	60,43 €
FO-110021	Tubo protección termo retráctil, especial para empalmes por fusión 60 mm (100 uds)	 FICHA TÉCNICA	1	0,11 €
FO-110022	Cortador de tubos de fibra óptica	 FICHA TÉCNICA	1	68,70 €
FO-110023	Herramienta para soplar y limpiar polvo en fibras	 FICHA TÉCNICA	1	15,54 €
FO-110024	Cortador de cable redondo de fibra óptica 3-35 mm	 FICHA TÉCNICA	1	48,91 €
FO-110025	Cinta limpiadora para conectores de fibra óptica	 FICHA TÉCNICA	1	66,74 €
FO-110026	Tubo protección termoretractil, especial para empalmes por fusión 40 mm (100unds)	 FICHA TÉCNICA	1	0,22 €



FO-110001



FO-110002











FO-120005



FO-120006

TERRA CATV

CÓDIGO	DESCRIPCIÓN		EMBAL.	€/UD
CATV				
TE-HA024R30	Amplificador CATV 1 sal, 30dB, 47-862 MHz, ajuste pend., 97 dB μ V, test, V.R. 5-30 MHz		1	84,24 €
TE-HA024R65	Amplificador CATV 1 sal, 30dB, 87-862 MHz, ajuste pend., 97 dB μ V, test, V.R. 5-65 MHz		1	83,15 €
TE-HA126R30	Amplificador CATV 1 sal, 34dB, 47-862 MHz, ajuste pend., 117 dB μ V, test, V.R. 5-30 MHz		1	100,54 €
TE-HA126R65	Amplificador CATV 1 sal, 34dB, 87-862 MHz, ajuste pend., 117 dB μ V, test, V.R. 5-65 MHz		1	84,78€
TE-HA209R65	Amplificador CATV 1 sal, 27/36 dB, 87-1002 MHz, ajuste pend, equa. interetapa, 109 dB μ V, E/S test, V.R. A/P 5-65 MHz		1	273,37 €
TE-HA205R65	Amplificador CATV 1 sal, 27/36 dB, 87-862 MHz, ajuste pend, equa. interetapa, 109 dB μ V, E/S test, V.R. A/P 5-65 MHz		1	186,19€
TE-HA209	Amplificador CATV 1 sal, 27/36 dB, 47-1002 MHz, ajuste pend, equa. interetapa, 109 dB μ V, E/S test		1	244,57 €
TE-HA129	Amplificador CATV 1 sal, 36dB, 47-862 MHz, ajuste pend., 100 dB μ V, test		1	93,95 €



TE-HA024R30



TE-HA126R30



TE-HA209



RED COMERCIAL TECATEL

**Central:
Oficinas, Post venta,
Almacén y Logística**

+34 962 800 404
info@tecatel.com

Andalucía

Francisco Bravo
670 553 057
fbravo@tecatel.com

Aragón

Luis Tormo
670 553 144
ltormo@tecatel.com

Alicante - Castellón - Valencia

Larysa Ponomarenko
670 553 063
levante@tecatel.com

Baleares

Laura Bañuls
670 200 090
lbanyuls@tecatel.com

Castilla la Mancha / Extremadura

Luis Tebar
670 552 798
ltebar@tecatel.com

Cataluña

Laura Bañuls
670 200 090
lbanyuls@tecatel.com

Galicia

Ángel Colino
607 524 799
galiciasmstv@tecatel.com

Las Palmas de Gran Canaria

Rogelio Rodriguez
670 553 098
rrodriguez@tecatel.com

Murcia - Almería

Larysa Ponomarenko
670 553 063
levante@tecatel.com

Santa Cruz de Tenerife

Andrés Fumero
670 553 028
afumero@tecatel.com

Zona Centro Madrid

Luis Tormo
670 553 144
ltormo@tecatel.com

Zona Norte

Laura Bañuls
670 200 090
lbanyuls@tecatel.com

División Internacional

Alfredo Belda
+34 670 552 415
abelda@tecatel.com



tecatel.com

